

Technical Specification
Fiber Optic Splice Closure
HTSC-214

Customer Approval			
	Name	Signature	Date
Approved by			

Contents

1. General	2
1.1 Description	2
1.2 Standards Comply	2
1.3 Applications Environment	2
2. Characteristics	3
3. Specifications	3
4. Product Picture	4
5. Configuration	4
5.1 Optical splice trays	4
5.2 Standard Accessories	5
5.3 Optional Accessories	6
6. Package	6

1. General

1.1 Description

Fiber optic splice closure is mainly applicable to the straight-through and branching of aerial cables, buried cables and duct cables, as well as the protection on cable joints.

Production type	Classification
HTSC-214	Fiber optic splice closure (dome type)



Appearance of HTSC-214

1.2 Standards Comply

ITU L.13	Performance requirements for passive optical nodes: Sealed closures for outdoor environments
----------	--

1.3 Applications Environment

Item	Value
Operation temperature	-40 °C ~ +65 °C
Installation temperature	-15 °C ~ +40 °C
Storage temperature	-45 °C ~ +75 °C

2. Characteristics

1. Dome mechanical sealing with advanced internal structure design.
2. High performance plastic, suitable for outdoor use, good weather resistant and UV resistance.
3. Efficiently structure installation design save time when assembling.
4. Easy for re-enter, easy for maintaining.
5. With oval input port, pass through route with branch is compatible.
6. IP rate: IP68
7. Pole-mounted, aerial-mounted, wall-mounted, hand hole-mounted are appropriate.

3. Specifications

Item	Specifications	Note
Material of housing	High-strength PP+GF	
Material of internal components	High-strength ABS	
Material of metal accessory	High-quality stainless steel	
External dimension(mm)	Φ230*345	
Color	Black	
Number of ports	1 oval port 4 round ports	
Fiber cable diameter of oval port (mm)	9-22 mm	
Fiber cable dimension of round port (mm)	8-17.5 mm	
Sealing type	Heat shrink sealing	
IP grade	IP68	
Splicing capacity(Max) (T108A)	4x24=96(Single fiber)	Splice tray type and quantity can be optional as customer's request
Splicing capacity(Max) (T059A)	4x24=96(Single fiber)	Splice tray type and quantity can be optional as customer's request

4.Product Picture

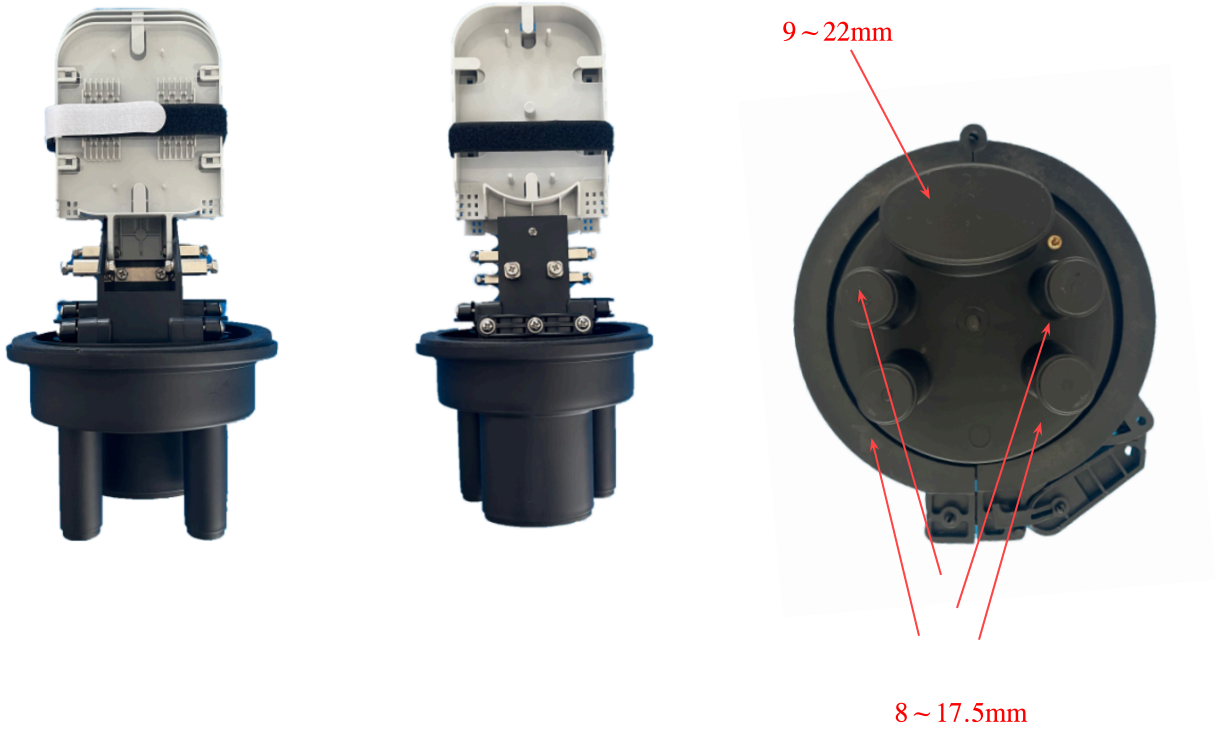

HTSC-214 product picture





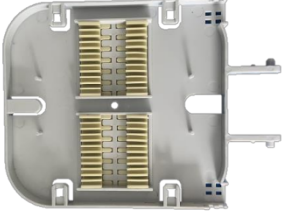

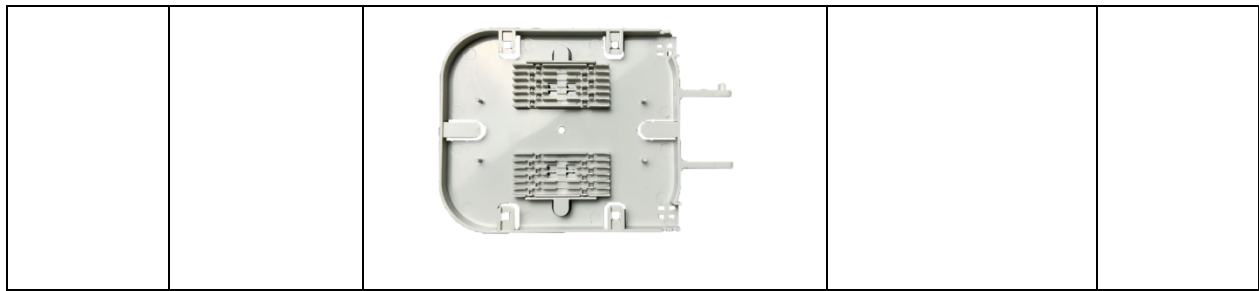
5. Configuration



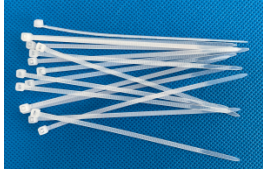

5.1 Optical splice trays

No	Model	Pic	Capacity	Note
				



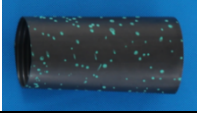

5.2 Standard Accessories

No.	Name	Reference picture	Quantity	Remark
1	Heat-shrinkable protection sleeve		1 bag	L=45mm (T059A) L=40mm (T108A)
2	Nylon cable tie		16 pcs	L=120mm
3	Branch clip		1 rolls	Black
4	Installation tape		1 roll	black
5	Buffer tube for bunchy fiber		n pcs	Each piece: OD=4.5mm, L=50cm QTY: n=trays number
6	Sand paper		1 pc	2.5cm*27cm
7	Aluminum foil		1 pc	10cm*25cm

8	Heat shrink tube(Oval port)		1 pc	Φ65x150mm
9	Heat shrink tube(Round port)		4 pc	Φ30x150mm
10	Installation manual		1pc	English
11	Desiccant		1 bag	5g/bag

5.3 Optional Accessories

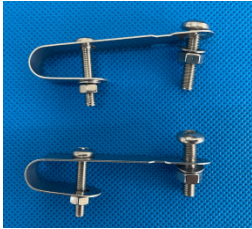
No.	Name	Model	Reference picture	Quantity	Remark
1	Pressure testing valve			1pc	
2	Earthing deriving device			1pc	
3	Pole-mounting kit	BZ22		1 set	
4	Aerial-mounting kit	JK02		1 set	

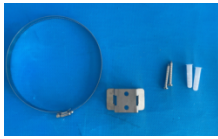
5	Wall-mounting kit	GB16		1 set	
---	-------------------	------	--	-------	--

6. Package

Standard

Double corrugated carton, 850*540*405 mm, 8 in carton, about 14.2Kg.