

Technical Specification  
**Fiber Optic Splice Closure**  
**HTSC-333-12SC**

<b>Customer Approval</b>			
	<b>Name</b>	<b>Signature</b>	<b>Date</b>
<b>Approved by</b>			

# Contents

1. General	2
1.1 Description	2
1.2 Standards Comply	2
1.3 Applications Environment	2
2. Characteristics	3
3. Specifications	3
4. Product Picture	4
5. Configuration	4
5.1 Optical splice trays	4
5.2 Sealing rubber ring specifications of straight-through cable ports	5
5.3 Sealing rubber ring specifications of branch cable ports	6
5.4 Standard Accessories	7
5.5 Optional Accessories	8
6. Package	8

## 1. General

### 1.1 Description

Fiber optic splice closure is mainly applicable to the straight-through and branching of aerial cables, buried cables and duct cables, as well as the protection on cable joints.

Production type	Classification
HTSC-333-12SC	Fiber optic splice closure (dome type)



Appearance of HTSC-333-12SC

### 1.2 Standards Comply

ITU L.13	Performance requirements for passive optical nodes: Sealed closures for outdoor environments
----------	--

### 1.3 Applications Environment

Item	Value
Operation temperature	-40 °C ~ +65 °C
Installation temperature	-15 °C ~ +40 °C
Storage temperature	-45 °C ~ +75 °C

## 2. Characteristics

1. Dome mechanical sealing with advanced internal structure design.
2. Efficiently structure installation design save time when assembling.
3. Tool free to re-enter, easy for maintaining.
4. Slide-in-lock design splice tray, to make opening angle about 90°
5. With oval input port, pass through route with branch is compatible.
6. Innovative elastic seal fitting.
7. IP68 protection can be offered.
8. Aerial, underground, wall-mounting, hand hole-mounting pole-mounting and duct-mounting are appropriate.

## 3. Specifications

Item	Specifications	Note
Material of housing	High-strength PP+GF	
Material of internal components	High-strength ABS	
Material of metal accessory	High-quality stainless steel	
External dimension(mm)	Φ293*414	
Color	Black	
Number of ports	1 large port , 6 round ports	
Fiber cable diameter of large port (mm)	Φ8~Φ22mm	
Fiber cable dimension of round port (mm)	Φ6~Φ20mm	
Sealing type	Mechanical	
IP grade	IP68	
simplex adaptors	12	
Splicing capacity(Max)	9x24=216F(Single fiber)	Optional as request

**4. Product Picture**



HTSC-333-12SC product picture



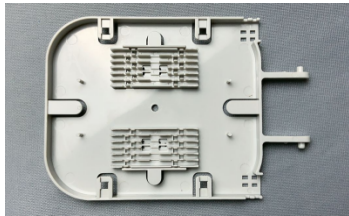
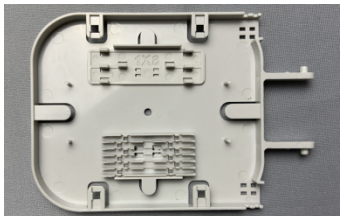

**5. Configuration**

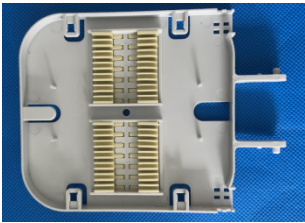
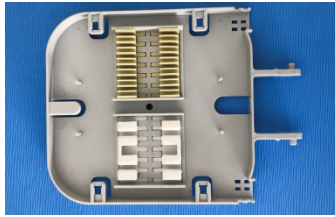
5.1 Optical splice trays

No	Model	Pic	Capacity	Note
1	T059A		24F(2 layer)	
2	T059B		12F(2 layers)+ 2 PLC splitters	



3	T059C		12F(2 layers)+ 1 PLC splitters	
4	T108A		24F(1 layer)	
5	T108B		12F(1 layers)+ 2 PLC splitters	

## 5.2 Sealing rubber ring specifications of straight-through cable ports

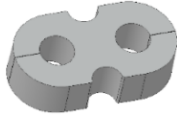



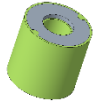
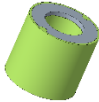
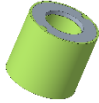
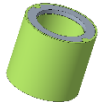
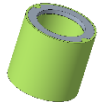

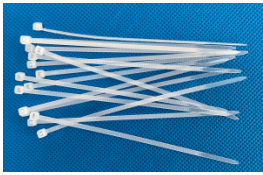

No.	Reference picture	Specifications	Remark
1		Φ8~10mm	<b>Note:</b> 1. Choose the appropriate size and quantity of sealing rubber ring according to the requirements, otherwise it will be provided according to the default configuration; 2. If one type is selected, it is pre-installed in the oval hole; if multiple types are selected, the larger size is pre-installed by default, and other types are packaged as accessories.
2		φ10~13.5mm	
3		Φ13.5~16mm	
4		Φ16~18mm <b>(Default, 1PC)</b>	

5		Φ18~20mm	
6		Φ20~22mm	

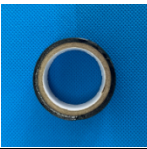
5.3 Sealing rubber ring specifications of branch cable ports

No.	Reference picture	Specifications	Remark
1		φ6-9mm	<p><b>Note:</b></p> <ol style="list-style-type: none"> <li>1. Choose the appropriate size and quantity of sealing rubber ring according to the requirements, otherwise it will be provided according to the default configuration;</li> <li>2. All branch hole sealing rubber rings are packaged as accessories by default.</li> </ol>
2		Φ9-12mm	
3		Φ12-15mm	
4		φ15-18mm <b>(Default, 6 PCS)</b>	
5		φ18-20mm	
6		16holes, 2*3mm	
7		4holes, 5*8mm	





## 5.4 Standard Accessories

No.	Name	Reference picture	Quantity	Note
1	Heat-shrinkable protection sleeve		1 bag	L=45mm ( T059A ) L=45mm ( T059B ) L=45mm ( T059C ) L=40mm ( T108A ) L=40mm ( T108B )
2	Nylon cable tie		16 pcs	L=120mm
3	Sealing tape		1 rolls	Black
4	Installation tape		1 roll	black
5	Buffer tube for bunchy fiber		n pcs	Each piece: OD=4.5mm, L=50cm QTY: n=trays number
6	Special wrench		1set	
7	Special wrench		1set	
8	gasket		6pcs	
9	Fiber optic cable plug		6pcs	
10	Sealing kit for branch cable		6sets	



11	Fiber optic cable plug		2pcs	
12	Installation manual		1pc	English
13	Desiccant		1 bag	5g/bag

### 5.5 Optional Accessories

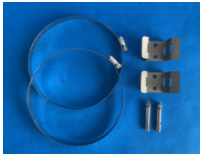
No.	Name	Model	Reference picture	Quantity	Note
1	Pressure testing valve			1pc	
2	Earthing deriving device			1pc	
3	Pole-mounting kit	BZ25		1 set	
4	Aerial-mounting kit	JK02		1 set	
5	Wall-mounting kit	GB19		1 set	

### 6. Package

Standard

Double corrugated carton, 620\*330\*430 mm, 2 in carton, about 10 Kg.