

Technical Specification  
**Fiber Optic Splice Closure**  
**HTSC-328**

<b>Customer Approval</b>			
	<b>Name</b>	<b>Signature</b>	<b>Date</b>
<b>Approved by</b>			

# Contents

1. General	2
1.1 Description	2
1.2 Standards Comply	2
1.3 Applications Environment	2
2. Characteristics	3
3. Specifications	3
4. Product Picture	4
5. Configuration	4
5.1 Optical splice trays	4
5.2 Optional Rubber Plug for Round Port	5
5.3 Sealing rubber ring specifications of straight-through cable ports	6
5.4 Standard Accessories	6
5.5 Optional Accessories	7
6. Package	8

**1. General**

1.1 Description

Fiber optic splice closure is mainly applicable to the straight-through and branching of aerial cables, buried cables and duct cables, as well as the protection on cable joints.

Production type	Classification
HTSC-328	Fiber optic splice closure (dome type)



Appearance of HTSC-328

1.2 Standards Comply

ITU L.13	Performance requirements for passive optical nodes: Sealed closures for outdoor environments
----------	--

1.3 Applications Environment

Item	Value
Operation temperature	-40 °C ~ +65 °C
Installation temperature	-15 °C ~ +40 °C
Storage temperature	-45 °C ~ +75 °C

## 2. Characteristics

1. Dome mechanical sealing with advanced internal structure design.
2. Efficiently structure installation design save time when assembling.
3. Tool free to re-enter, easy for maintaining.
4. Slide-in-lock design splice tray, to make opening angle about 90°
5. With oval input port, pass through route with branch is compatible.
6. Innovative elastic seal fitting.
7. IP68 protection can be offered.
8. Suitable for bunchy and ribbon fibers.
9. Aerial, underground, wall-mounting, hand hole-mounting pole-mounting and duct-mounting are appropriate.

## 3. Specifications

Item	Specifications	Note
Material of housing	High-strength PP+GF	
Material of internal components	High-strength ABS	
Material of metal accessory	High-quality stainless steel	
External dimension(mm)	450*220*208	
Color	Black	
Number of ports	1 oval port, 5 round ports	
Fiber cable diameter of oval port (mm)	Φ6~Φ17.5mm	
Fiber cable dimension of round port (mm)	Φ6~Φ17.5mm	
Sealing type	Mechanical	
IP grade	IP68	
Splicing capacity(Max)	16x12=192F	Optional as request

**4.Product Picture**

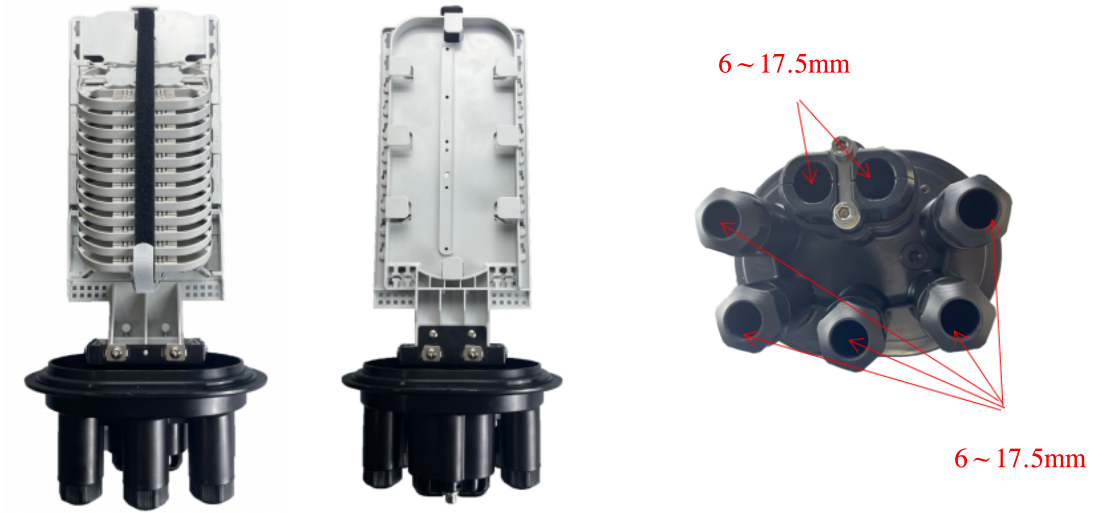

HTSC-328 product picture

**5. Configuration**

5.1 Optical splice trays

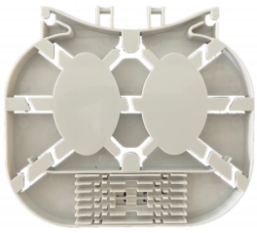



No	Model	Pic	Capacity	Note
1	T095A		12F(2 layer)	

5.2 Optional Rubber Plug for Round Port





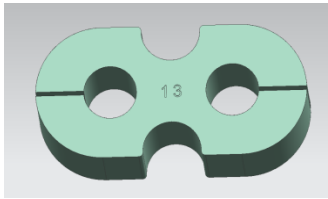

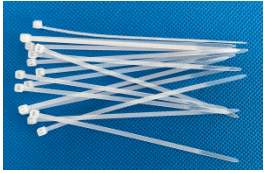

No	Moudel	Pic	Specification	Note
1	DT04-A		9holes, 2*5mm	
2	DT04-B		9holes, $\Phi$ 3mm	
3	DT04-C		4holes, $\Phi$ 5.3mm	
4	DT04-D		9holes, 2*5mm	
5	DT04-H		Big hole, $\Phi$ 17.5mm Small hole, $\Phi$ 10mm	
6	DT04-I		Big hole, $\Phi$ 17.5mm Small hole, $\Phi$ 13mm	

7	DT04-J		12holes, 2*3mm	
---	--------	---	----------------	--

5.3 Sealing rubber ring specifications of straight-through cable ports

No	Moudel	Pic	Specification	Note
1	DT03-A		$\phi 14 \sim \phi 17.5 \text{mm}$	Default, 1 PCS
2	DT03-B		$\Phi 8 \sim \phi 11 \text{mm}$	
3	DT03-C		$\phi 11 \sim \phi 14 \text{mm}$	
4	DT03-D		$\Phi 6 \sim \phi 8 \text{mm}$	





## 5.4 Standard Accessories

No.	Name	Reference picture	Quantity	Note
1	Heat-shrinkable protection sleeve		1 bag	L=45mm(T059A)
2	Nylon cable tie		16 pcs	L=120mm
3	Special wrench		1set	
4	Sealing tape		1 rolls	Black
5	Installation tape		1 roll	black
6	Buffer tube for bunchy fiber		n pcs	Each piece: OD=4.5mm, L=50cm QTY: n=trays number
7	Special wrench		1set	
8	gasket		5pcs	
9	Fiber optic cable plug		5pcs	$\phi$ 13.5
10	Fiber optic cable plug		2pcs	$\Phi$ 17.5



11	Sealing kit for branch cable		5sets	
12	Installation manual		1pc	English
13	Desiccant		1 bag	5g/bag

5.5 Optional Accessories

No.	Name	Model	Reference picture	Quantity	Note
1	Pressure testing valve			1pc	
2	Earthing deriving device			1pc	
3	Pole-mounting kit	BZ26		1 set	
4	Aerial-mounting kit	JK02		1 set	
5	Wall-mounting kit	GB20		1 set	

**6. Package**

Standard                      Double corrugated carton, 730\*515\*455 mm, 6 in carton, about 24Kg.