

Technical Specification
**Pre-connectorized Fiber Optic Cable Distribution
Box
HTTC-17B**

Customer Approval			
	Name	Signature	Date
Approved by			

Contents

1. General	2
1.1 Description	2
1.2 Standards Comply	2
1.3 Applications Environment	2
2. Characteristics	3
3. Specifications	3
4. Product Picture	4
5. Configuration	4
5.1 Standard Accessories	4
5.2 Optional Accessories	5
6. Package	5

1. General

1.1 Description

Fiber optic splice closure is mainly applicable to the straight-through and branching of aerial cables, buried cables and duct cables, as well as the protection on cable joints.

Production type	Classification
HTTC-17B	Pre-connectorized Fiber optic cable distribution box



Appearance of HTTC-17B

1.2 Standards Comply

The production offered by our company are designed, manufactured and tested according to the standards as follows:

ITU L.13	Sheath joints and organizers of optical fiber cables in the outside plant
IEC61300-2	Fiber optic interconnecting devices and passive components - Basic test and measurement procedures
IEC60068-2	Basic environmental testing procedures for electric and electronic products

1.3 Applications Environment

Item	Value
Operation temperature	-40 °C ~ +65 °C
Installation temperature	-15 °C ~ +40 °C
Storage temperature	-45 °C ~ +75 °C

2. Characteristics

1. Totally enclosed structure, the bottom shell and upper cover are welded by ultrasonic welding, which is non-detachable.

2. Material: PP+GF

3. Moisture proof, waterproof, dust-proof, anti-aging.

4. Protection level up to IP68.

5. The interior is equipped with 1x2 FTB splitter, 1x8 PLC splitter.

6. Installation method: pole-mounted, aerial-mounted, wall-mounted · hand hole, man hole · etc.

7. It can be equipped with drop cable storage tray to meet the storage of 30 meters 5mm round cable.

3. Specifications

Item	Specifications	Note
Material of housing	High-strength PP+GF	
Material of internal components	High-strength ABS	
Material of metal accessory	High-quality stainless steel	
External dimension(mm)	198mm x 187mm x 74mm (AxBxC)	
Color	Black	
Number of Pre-connectorized adaptors	9	(1 red,8 black)
Splitter	1x4 PLC splitter	
	1x8 PLC splitter	
IP grade	IP68	

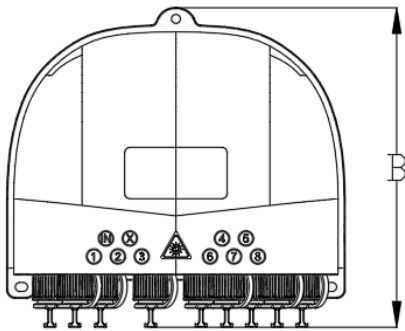
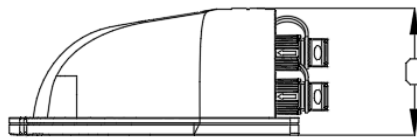
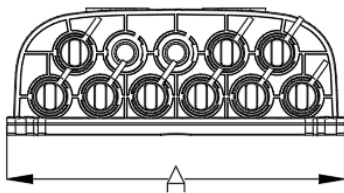



4. Product Picture



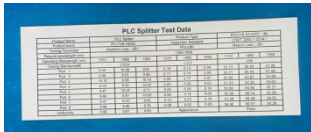

HTTC-17B product picture

5. Configuration

5.1 Standard Accessories

No.	Name	Reference picture	Quantity	Remark
1	Splitter test report		1pc	English
2	Installation manual		1pc	English
3	Protective cover		9 pcs	

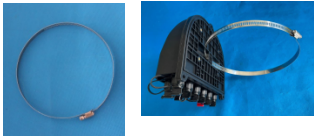
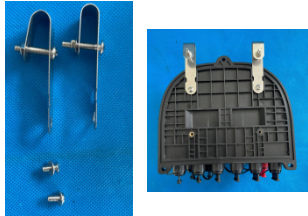
5.2 Optional Accessories

No.	Name	Model	Reference picture	Quantity	Remark
1	Pole-mounting kit			1 set	Optional as customer's request
2	Aerial-mounting kit	JK06		1 set	Optional as customer's request
3	Wall-mounting kit			1 set	Optional as customer's request

6. Package

Standard

Double corrugated carton,810*410*430MM, 40 in carton,about 25KG.